



ENSURING THE EXPERTISE TO GROW SOUTH AFRICA

Engineering Qualifications in the Higher Education Qualifications Sub-framework

E-23-P

REVISION 2: 13 July 2022

ENGINEERING COUNCIL OF SOUTH AFRICA
Tel: 011 607 9500 | Fax: 011 622 9295
Email: engineer@ecsa.co.za | Website: www.ecsa.co.za





Document No.: E-23-P	Revision No.: 2	Effective Date: 13/07/2022	
Subject: Engineering Qualifications in the Higher Education Qualifications Sub-framework			
Compiler: P Kutame	Approving Officer: MB Mtshali	Next Review Date: 13/07/2026	Page 2 of 17

TABLE OF CONTENTS

DEFINITIONS	3
ABBREVIATIONS	5
1. PURPOSE OF THIS DOCUMENT	6
2. BACKGROUND TO ENGINEERING QUALIFICATIONS	6
3. PRINCIPLES UNDERLYING THE ENGINEERING QUALIFICATION STRUCTURE	7
4. BENCHMARKS AND PATHWAYS	9
4.1 Pathways to Benchmark 1: Educational requirements for Professional Engineers	9
4.2 Pathways to Benchmark 2: Educational requirements for Professional Engineering Technologists	11
4.3 Pathways to Benchmark 3: Educational requirements for Professional Engineering Technicians	13
4.4 Pathways to Benchmark 4: Educational requirements for Professional Certificated Engineers	13
4.5 Pathways to Benchmark 5: Educational requirements for Specified Categories	14
REVISION HISTORY	16

CONTROLLED DISCLOSURE

When downloaded for the ECSA Document Management System, this document is uncontrolled and the responsibility rests with the user to ensure that it is in line with the authorised version on the database. If the 'original' stamp in red does not appear on each page, this document is uncontrolled.

Document No.: E-23-P	Revision No.: 2	Effective Date: 13/07/2022	
Subject: Engineering Qualifications in the Higher Education Qualifications Sub-framework			
Compiler: P Kutame	Approving Officer: MB Mtshali	Next Review Date: 13/07/2026	Page 3 of 17

DEFINITIONS

Accreditation: Formal recognition awarded to an education or training programme through a quality assurance procedure that ensured it met the criteria laid down for the type of programme.

Assessment: The process of determining the capability or competence of an individual by evaluating performances against standards.

Benchmark [for a category of registration]: The required educational achievement expressed in terms of minimum credits in total and at the exit-level, graduate attributes, the level of problem solving, and a knowledge profile, but not specifying the qualifications, learning pathways or programmes to achieve the benchmark.

Category: A mode of registration defined in or under the Engineering Profession Act, 46 of 2000, that has a distinctive purpose, characteristic competencies, educational requirements and defined principal routes to registration.

Education provider: A public or private higher education institution or body that conducts programmes leading to accredited ECSA engineering qualifications of any type.

Engineering education programme: An educational programme that aims to satisfy criteria prescribed by the ECSA.

Engineering Specialty: The extension of engineering fundamentals to create theoretical frameworks and bodies of knowledge for engineering practice areas.

Graduate: A qualifying learner, irrespective of whether the qualification is a degree or a diploma.

Graduate Attribute: A statement of the learning outcomes that a student must demonstrate at exit-level to qualify for an award of a qualification; these actions indicate the student's capability to fulfil the educational objectives.

Level: A measure of learning demands regarding types of problems, knowledge required, skills and responsibility, which are expressed in terms of level descriptors.

CONTROLLED DISCLOSURE

When downloaded for the ECSA Document Management System, this document is uncontrolled and the responsibility rests with the user to ensure that it is in line with the authorised version on the database. If the 'original' stamp in red does not appear on each page, this document is uncontrolled.

Document No.: E-23-P	Revision No.: 2	Effective Date: 13/07/2022	
Subject: Engineering Qualifications in the Higher Education Qualifications Sub-framework			
Compiler: P Kutame	Approving Officer: MB Mtshali	Next Review Date: 13/07/2026	Page 4 of 17

Pathway: Defined arrangement of teaching, learning and assessment within a programme that is one way of gaining the award of a qualification.

Programme: A structured, integrated teaching and learning arrangement with a defined purpose and pathway that leads to a qualification.

Provider: A higher education provider except if the context indicates otherwise.

Qualification: The formal recognition of a specified learning achievement that is usually awarded upon successful completion of a programme.

Stage One: A point in the process of professional or occupational development in engineering at which a person fulfils the educational requirements to register as a Candidate in the relevant category.

Standards: Statements of outcomes to be demonstrated and the levels of performance and content baseline requirements in the context of engineering educational programmes.

CONTROLLED DISCLOSURE

When downloaded for the ECSA Document Management System, this document is uncontrolled and the responsibility rests with the user to ensure that it is in line with the authorised version on the database. If the 'original' stamp in red does not appear on each page, this document is uncontrolled.

Document No.: E-23-P	Revision No.: 2	Effective Date: 13/07/2022	
Subject: Engineering Qualifications in the Higher Education Qualifications Sub-framework			
Compiler: P Kutame	Approving Officer: MB Mtshali	Next Review Date: 13/07/2026	Page 5 of 17

ABBREVIATIONS

AC	Accreditation Committee
Adv Cert	Advanced Certificate
Adv Dip	Advanced Diploma
Adv Dip Eng	Advanced Diploma in Engineering
BEng	Bachelor of Engineering
BSc (Eng)	Bachelor of Science in Engineering
BEng Tech	Bachelor of Engineering Technology
BEng Tech (Hons)	Bachelor of Engineering Technology (Hons)
BTech	Bachelor of Technology
CHE	Council on Higher Education
Dip Eng	Diploma in Engineering
Dip Eng Tech	Diploma in Engineering Technology
EC	Education Committee
ECSA	Engineering Council of South Africa
GA	Graduate Attribute
GCC	Government Certificate of Competence
HCert	Higher Certificate
HEQC	Higher Education Quality Committee
HEQSF	Higher Education Qualifications Sub-Framework
LMS	Learning Management System
MEng	Master of Engineering
ND	National Diploma
NQF	National Qualifications Framework
PCE	Professional Certificated Engineer
PGDip Eng Tech	Post Graduate Diploma in Engineering Technology
RSPC	Research, Policy and Standards Committee
SADC	Southern African Development Community
SAQA	South African Qualifications Authority

CONTROLLED DISCLOSURE

When downloaded for the ECSA Document Management System, this document is uncontrolled and the responsibility rests with the user to ensure that it is in line with the authorised version on the database. If the 'original' stamp in red does not appear on each page, this document is uncontrolled.

Document No.: E-23-P	Revision No.: 2	Effective Date: 13/07/2022	
Subject: Engineering Qualifications in the Higher Education Qualifications Sub-framework			
Compiler: P Kutame	Approving Officer: MB Mtshali	Next Review Date: 13/07/2026	Page 6 of 17

1. PURPOSE OF THIS DOCUMENT

This document examines the qualification types defined in the Higher Education Qualifications Sub-framework¹ (HEQSF) in the light of the education requirements for the various professional, candidate and specified categories defined in terms of the Engineering Professions Act. This document is informative, not normative, and is likely to evolve over time. It identifies qualification types that may satisfy education requirements for various engineering registration categories.

2. BACKGROUND TO ENGINEERING QUALIFICATIONS

Engineering is a wide field of study and practice, as evidenced by the substantial number of recognised disciplines, sub-disciplines and practice areas as well as engineer, engineering technologist, engineering technician, specified category practitioner, and certificated engineer roles that are required for typical engineering work. Development of engineering competence at a level where a person is able to practise independently has two stages:

- First, an educational foundation is laid through the attainment of a qualification, often referred to as the Stage One requirement.
- Second, training and experience in the workplace completes the development of competency.

Standards for a number of engineering roles have been developed by the Research, Policy & Standards (RPS) committee for the Engineering Council of South Africa (ECSA). Higher educational qualifications must conform to HEQSF types. The professional roles covered by these standards that rely on HEQSF-compliant educational qualifications are:

- Professional Engineer (**Engineers**)
- Professional Engineering Technologist (**Engineering Technologists**)
- Professional Engineering Technician (**Engineering Technicians**).

¹ Department of Higher Education and Training, *Higher Education Qualifications Sub-Framework*, Department of Education. 2013, Government Gazette: Pretoria.

CONTROLLED DISCLOSURE

When downloaded for the ECSA Document Management System, this document is uncontrolled and the responsibility rests with the user to ensure that it is in line with the authorised version on the database. If the 'original' stamp in red does not appear on each page, this document is uncontrolled.

Document No.: E-23-P	Revision No.: 2	Effective Date: 13/07/2022	
Subject: Engineering Qualifications in the Higher Education Qualifications Sub-framework			
Compiler: P Kutame	Approving Officer: MB Mtshali	Next Review Date: 13/07/2026	Page 7 of 17

Each professional category has a corresponding candidate category, for example Candidate Engineer, with the category's educational requirements as the sole admission requirement. Other roles for which the RPSC has developed standards are the Professional Certificated Engineer (PCE) and the Specified Categories of registration focused on the statutory health and safety function that ECSA is empowered to create.

This document presents the structure and underlying logic of engineering qualifications in the HEQSF. This structure provides for the Engineer, Engineering Technologist and Engineering Technician qualifications as well as opportunities for categories not at present served by dedicated higher education qualifications. This structure identifies multiple routes leading to the necessary graduate attributes for the various roles as well as routes for crossing over from one role to another.

Section 3 identifies the principles underlying engineering qualifications. Section 4 identifies pathways in terms of HEQSF-compliant qualifications.

3. PRINCIPLES UNDERLYING THE ENGINEERING QUALIFICATION STRUCTURE

Five educational benchmarks are identified for the five forms of registration that can be attained by a defined qualification or combination of qualifications:

- **Benchmark 1:** Meeting the educational requirement for *engineers*
- **Benchmark 2:** Meeting the educational requirement for *engineering technologists*
- **Benchmark 3:** Meeting the educational requirement for *engineering technicians*
- **Benchmark 4:** Meeting the educational requirement for *certificated engineers*
- **Benchmark 5:** Meeting the educational requirement for *specified categories*.

The educational requirement for each Benchmark is defined in terms of:

- a professional purpose
- an NQF level, minimum total credits, and credits at the exit-level
- a set of graduate attributes

CONTROLLED DISCLOSURE

When downloaded for the ECSA Document Management System, this document is uncontrolled and the responsibility rests with the user to ensure that it is in line with the authorised version on the database. If the 'original' stamp in red does not appear on each page, this document is uncontrolled.

Document No.: E-23-P	Revision No.: 2	Effective Date: 13/07/2022	
Subject: Engineering Qualifications in the Higher Education Qualifications Sub-framework			
Compiler: P Kutame	Approving Officer: MB Mtshali	Next Review Date: 13/07/2026	Page 8 of 17

- a level descriptor for problem solving
- a knowledge profile expressed both in terms of the minimum volume of credits in specific knowledge areas and the type of knowledge at the exit-level.

Standards for qualifications leading to Benchmarks 1, 2 and 3 define generic requirements across all disciplines, sub-disciplines or practice areas, not for specific disciplines. Benchmark 4 has additional specific requirements for different types of certificated engineers. In the case of specified categories² Benchmark 5, the ECSA standard is at present generic across all such categories.

In the interests of promoting progression toward and articulation between categories, the set of qualification standards attempts to identify all feasible pathways (that is, sequences of qualifications) to Benchmarks 1, 2, 3 and 4. A single pathway leads to Benchmark 5.

This document describes the possibilities for meeting engineering education benchmark requirements within the set of qualification types defined in the HEQSF. As demonstrated below, every HEQSF qualification type (except for doctoral degrees) could be achieved on various pathways. There is no implied obligation on higher education providers to implement all pathways to benchmarks appropriate to the type of university.

Graduates completing pathways to benchmarks having different highest qualifications, while not necessarily having completed identical curricula, are considered to possess substantially equivalent educational qualifications for registration in the relevant category. The standards for programmes along pathways must ensure this substantial equivalence at the exit level. Each programme on a pathway must have a defined, meaningful stand-alone purpose.

In the accreditation process, the suite of actual programmes that constitutes a pathway must be accredited against the standards in the light of the programmes' roles in the pathway.

² The Certificated Engineer qualifications do not follow the usual model as this form of registration with ECSA requires the prior attainment of a Government Certificate of Competence (GCC). The various authorities responsible for the GCC examinations use selected existing qualifications as part of the admission requirements for the examinations. It is assumed that these authorities will use HEQSF qualification types as these are introduced.

CONTROLLED DISCLOSURE

When downloaded for the ECSA Document Management System, this document is uncontrolled and the responsibility rests with the user to ensure that it is in line with the authorised version on the database. If the 'original' stamp in red does not appear on each page, this document is uncontrolled.

Document No.: E-23-P	Revision No.: 2	Effective Date: 13/07/2022	
Subject: Engineering Qualifications in the Higher Education Qualifications Sub-framework			
Compiler: P Kutame	Approving Officer: MB Mtshali	Next Review Date: 13/07/2026	Page 9 of 17

Accreditation decisions must be recorded for the programme in relation to the pathway and any other approved stand-alone purpose.

4. BENCHMARKS AND PATHWAYS

Five educational benchmarks associated with the four identified professional roles and the various specified categories are listed above and considered in turn. Figure 1 provides a graphical overview of the pathways to benchmarks and their constituent qualifications. The set of qualifications available for the construction of pathways is listed in Table 1. Table 2 lists the pathways for consideration to the benchmarks.

In the description of pathways that follows, each pathway is identified by the notation Px.y where the first number, x, is the Benchmark (Bx as shown in Figure 1) and the second, y, is the pathway to that Benchmark. For example, P3.1 is the first defined pathway to Benchmark 3.

4.1 Pathways to Benchmark 1: Educational requirements for Professional Engineers

Four pathways to Benchmark 1 defining the educational requirements for Candidate and Professional Engineers have been identified by the RPSC.

Pathway P.1.1: This pathway is the longstanding route to meeting the educational requirements for Professional Engineers³ via the Bachelor of Engineering degree (**E-02-PE**), also titled Bachelor of Science in Engineering, but equivalent in all respects. This pathway has existed in its present form for four decades and the present qualification standard, dating from 2000 and periodically revised, is internationally benchmarked, mature and fully tested.

Pathway P1.2: In a number of disciplines, the possibility exists for enhancing the educational knowledge by enabling a deeper study of the underlying natural sciences, or where the natural

³ This document often refers only to the professional registration category, for example Professional Engineer. The same education requirements apply as the sole requirements for registration in the corresponding candidate category, for example Candidate Engineer. This should be taken as read in the Engineer, Certificated Engineer, Engineering Technologist, Engineering Technician and specified category cases.

CONTROLLED DISCLOSURE

When downloaded for the ECSA Document Management System, this document is uncontrolled and the responsibility rests with the user to ensure that it is in line with the authorised version on the database. If the 'original' stamp in red does not appear on each page, this document is uncontrolled.

Document No.: E-23-P	Revision No.: 2	Effective Date: 13/07/2022	
Subject: Engineering Qualifications in the Higher Education Qualifications Sub-framework			
Compiler: P Kutame	Approving Officer: MB Mtshali	Next Review Date: 13/07/2026	Page 10 of 17

science base may be more extensive than required, while laying the engineering science foundations. The pathway involves a 3-year bachelor's degree (360–420 credits total) with a prescribed curriculum designed to give advanced entry to specific cognate BEng/BSc (Eng) programmes with at least 280 credits (2 academic years), including at least 120 credits at the exit-level to be completed. The 3-year degree may be titled Bachelor of Engineering Science or Bachelor of Science. In the latter case, major subject requirements may apply. This pathway allows universities not having BEng programmes to design and have accredited arrangements to feed students to those universities that have. Universities determine the point of entry.

Pathway P1.3: This pathway is an option that arises from the HEQSF-compliant qualification for engineering technologist education, the BEng Tech (**E-02-PT**). It seeks to build on pathway P2.1 for Engineering Technologists. The assumption is that qualifications on this pathway contain sufficient and appropriate mathematics, natural science and engineering fundamentals as the BEngSc and BSc/BEng programmes in pathway P1.2. The Education Committee evaluates the programmes along each pathway and decides on each in terms of the relevant benchmark.

Pathway P1.4: This pathway builds vertically on pathway P2.1 to meet the engineer educational benchmark. The BEng Tech is followed by a PGDip/BEng Tech (Honours) degree in the same or cognate discipline. (Note that the CHE has indicated that the PGDip is the preferred qualification on this pathway as an honours qualification should lead to a research-focused master's qualification.) This alone will not give substantial equivalence with the BSc/BEng. The BEng Tech must be followed by a combination of qualifications that together meet or exceed the requirements for the BSc/BEng. This is provided by a PGDip (Engineering) (**E-09-PGDip**)/ BEng Tech (Honours) (**E-09-PT**) with an appropriate curriculum, followed by a suitably structured Professional Master's Degree (**E-22-P**). These two qualifications should form a curriculum as a coherent whole, typically provided by a single provider as a suite of offerings.

Figure 1 suggests the possibility of pathway P1.4 building on P2.2 (which in turn builds on P3.1).

CONTROLLED DISCLOSURE

When downloaded for the ECSA Document Management System, this document is uncontrolled and the responsibility rests with the user to ensure that it is in line with the authorised version on the database. If the 'original' stamp in red does not appear on each page, this document is uncontrolled.

Document No.: E-23-P	Revision No.: 2	Effective Date: 13/07/2022	
Subject: Engineering Qualifications in the Higher Education Qualifications Sub-framework			
Compiler: P Kutame	Approving Officer: MB Mtshali	Next Review Date: 13/07/2026	Page 11 of 17

4.2 Pathways to Benchmark 2: Educational requirements for Professional Engineering Technologists

The Professional Engineering Technologist is envisaged as having mastery of and applying established technology to problems that are amenable to solution by that technology. The required education base is different to that of the engineer; mathematics and natural science foundation underpin the sub-discipline.

Models for the education of Engineering Technologists in countries that recognise this role fall into two patterns: first dedicated bachelor's degrees, typically of 3 years duration and, second, building on technician education, typically with 1 or more years additional study. Both routes are possible under the HEQSF and the RPSC standards seek to support both patterns.

The potential pathways to the Engineering Technologist Benchmark 2 are as follows:

Pathway P2.1: The Bachelor of Engineering Technology (BEng Tech) (**E-02-PT**) is a 3-year professionally oriented bachelor's degree benchmarked to international standards for engineering technologist education.

Pathway P2.2: Along with the next two pathways, this one builds on engineering technician education pathways, thus implementing the second pattern of technologist qualifications. Having completed the Dip Eng (**E-02-PN**) pathway P3.1 qualification for technicians, the student goes on to an Advanced Diploma (**E-05-PT**) in an engineering sub-discipline. The Advanced Diploma has graduate attributes that match those of the BEng Tech. The student completes 500 credits as opposed to the 420 of the BEng Tech.

CONTROLLED DISCLOSURE

When downloaded for the ECSA Document Management System, this document is uncontrolled and the responsibility rests with the user to ensure that it is in line with the authorised version on the database. If the 'original' stamp in red does not appear on each page, this document is uncontrolled.

Document No.: E-23-P	Revision No.: 2	Effective Date: 13/07/2022	
Subject: Engineering Qualifications in the Higher Education Qualifications Sub-framework			
Compiler: P Kutame	Approving Officer: MB Mtshali	Next Review Date: 13/07/2026	Page 12 of 17

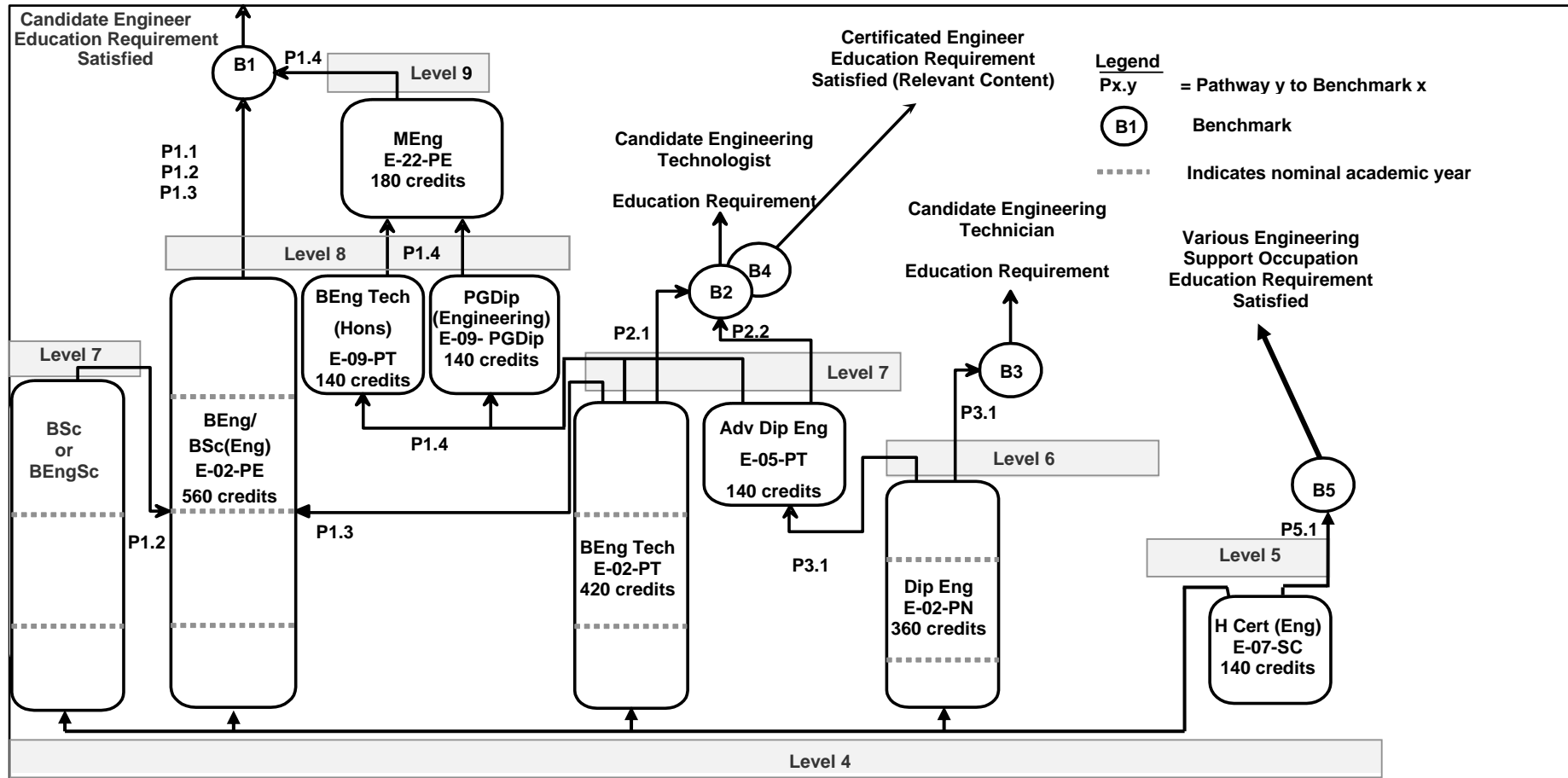



Figure 1: Graphical view of engineering qualifications in the HEQSF. Each pathway is identified by the notation Px.y where the first number, x, is the Benchmark (Bx as shown in Figure 1) and the second, y, is the pathway to that Benchmark

CONTROLLED DISCLOSURE

When downloaded for the ECSA Document Management System, this document is uncontrolled and the responsibility rests with the user to ensure that it is in line with the authorised version on the database. If the 'original' stamp in red does not appear on each page, this document is uncontrolled.

Document No.: E-23-P	Revision No.: 2	Effective Date: 13/07/2022	
Subject: Engineering Qualifications in the Higher Education Qualifications Sub-framework			
Compiler: P Kutame	Approving Officer: MB Mtshali	Next Review Date: 13/07/2026	Page 13 of 17

4.3 Pathways to Benchmark 3: Educational requirements for Professional Engineering Technicians

The qualification for Engineering Technicians is an HEQSF-compliant, 360-credit diploma incorporating work-integrated learning, the Diploma in Engineering (Dip Eng) (**E-02-PN**). The HEQSF provides a building block for the Engineering Technician pathway: the Higher Certificate (**E-07-PN**).⁴

The pathway to Benchmark 3 is as follows:

Pathway P3.1: A 360-credit Diploma, the Diploma in Engineering (Dip Eng) (**E-02-PN**) incorporating work-integrated learning, defines this pathway. The diploma is awarded in an engineering sub-discipline or practice area. At least 30 credits (900 hours⁵) of work-integrated learning is required.

4.4 Pathways to Benchmark 4: Educational requirements for Professional Certificated Engineers

The present higher educational qualification requirements for PCEs are those used as part of the admission process, along with experience, to the GCC examinations set by the relevant authorities in the mining, factories and marine areas. The GCC (and an appointment as a responsible person in terms of the applicable Act) is then the ECSA entry requirement for Candidate Certificated Engineer and in this context functions like a higher education qualification.

The generalised competency of a PCE is at least that of a Professional Engineering Technologist. In the mining field, the engineering knowledge is comparable to a Professional Engineering Technologist in mining engineering. Specialised knowledge in mining health and safety and the applicable law distinguishes the PCE from the Professional Engineering

⁴ Although the Higher Certificate is currently only offered by Universities of Technology, there is a move to have these offered by TVET colleges in the future.

⁵ The ECSA credit calculation formula (see **E-01-P**) assigns one credit per 30 hours of work-integrated learning.

CONTROLLED DISCLOSURE

When downloaded for the ECSA Document Management System, this document is uncontrolled and the responsibility rests with the user to ensure that it is in line with the authorised version on the database. If the 'original' stamp in red does not appear on each page, this document is uncontrolled.

Document No.: E-23-P	Revision No.: 2	Effective Date: 13/07/2022	
Subject: Engineering Qualifications in the Higher Education Qualifications Sub-framework			
Compiler: P Kutame	Approving Officer: MB Mtshali	Next Review Date: 13/07/2026	Page 14 of 17

Technologist. In the factories/works and marine area, the broader engineering knowledge is drawn from the fields of electrical and mechanical engineering. Specialist knowledge relates to industrial or marine plant operation, occupational health and safety and the applicable law. Thus, programmes designed to educate PCEs would have substantial common content with the Professional Engineering Technologist programmes in mining and selected electrical and mechanical engineering subjects but would cover the educational material specific to the GCC being targeted. Graduate attributes are the same.

The possible future pathways for Certificated Engineers are therefore as for Professional Engineering Technologists and so are not re-defined here.

4.5 Pathways to Benchmark 5: Educational requirements for Specified Categories

Specified Categories are defined by ECSA to meet the specific requirements of other legislation that requires an engineering-related function to be performed or engineering work to be carried out at a specifically defined level. These functions are generally carried out in terms of defined codes or procedures in a narrow specific sub-discipline. In the past, there has not been dedicated education for specified categories and persons have come to the categories from various backgrounds, for example an artisan progressing to lifting machinery inspector. ECSA has now defined educational requirements under the HEQSF Higher Certificate in Engineering. These are generic and applicable to all specified category practitioners.

NOTE: Some pathways in this revision have been deprecated as providers and the CHE have engaged regarding the appropriateness of the inclusion of various qualifications available through the HEQSF:

- Advanced Certificate (Engineering) – E-06-PN
- Advanced Certificate (Engineering Practice) – E-21-PN
- Diploma Engineering Technology – E-08-PN

CONTROLLED DISCLOSURE

When downloaded for the ECSA Document Management System, this document is uncontrolled and the responsibility rests with the user to ensure that it is in line with the authorised version on the database. If the 'original' stamp in red does not appear on each page, this document is uncontrolled.



Document No.: E-23-P	Revision No.: 2	Effective Date: 13/07/2022	
Subject: Engineering Qualifications in the Higher Education Qualifications Sub-framework			
Compiler: P Kutame	Approving Officer: MB Mtshali	Next Review Date: 13/07/2026	Page 15 of 17

Table 1: Pathways to Benchmarks

Benchmark	Pathway	Qualifications on Pathway	Total Credits	HEQSF Level
1: "engineer"	P1.1	BEng/BSc (Eng)	560	8
	P1.2	BEngSci or BSc (prescribed curriculum) with advanced entry to BEng/BSc (Eng)	360–420	7
			280	8
	P1.3	BEng Tech with advanced entry to BEng/BSc (Eng)	420 280	7 8
P1.4	BEng Tech PGDip (Engineering) E-09-PT MEng	420	7	
		140	8	
		140	8	
		180	9	
2: "engineering technologist"	P2.1	BEng Tech	420	7
	P2.2	Dip Eng Adv Dip Eng	360	6
140			7	
3: "engineering technician"	P3.1	Dip Eng	360	6
4: "certificated engineer"	P4.1	As for engineering technologist route 1 with PCE-oriented content in BEng Tech	As for P2.1	7
	P4.2	As for engineering technologist route 2 with PCE-oriented content in Adv Dip Eng	As for P2.2	7
5: "specified category"	P5.1	H Cert (Eng) + specified category	140	5

CONTROLLED DISCLOSURE

When downloaded for the ECSA Document Management System, this document is uncontrolled and the responsibility rests with the user to ensure that it is in line with the authorised version on the database. If the 'original' stamp in red does not appear on each page, this document is uncontrolled.

Document No.: E-23-P	Revision No.: 2	Effective Date: 13/07/2022	
Subject: Engineering Qualifications in the Higher Education Qualifications Sub-framework			
Compiler: P Kutame	Approving Officer: MB Mtshali	Next Review Date: 13/07/2026	Page 16 of 17

REVISION HISTORY

Revision number	Revision date	Revision details	Approved by
Draft A	25 Feb 2015	Document converted to E-series format and revised at request of ESGB	ESGB
Draft B	4 June 2016	Figure 1 updated. For approval by SGG members and ESGB.	SGG appointed by the ESGB
Draft C	1 June 2018	Revised in light of the finalisation of the various qualification standards.	WG appointed by the PSDG
Draft E	22 October 2018	Updated the nomenclature for the various qualification types	WG appointed by the PSDG
Revision 1	17 April 2019	Approval	RPSC
Revision 2 Draft A	22 June 2022	Updated to reflect changes to pathways as operationalised by providers and the CHE. Some pathways in this revision have been deprecated as providers and the CHE have engaged regarding the appropriateness of the inclusion of various qualifications available through the HEQsF: Advanced Certificate (Engineering) – E-06-PN Advanced Certificate (Engineering Practice) – E-21-PN Diploma Engineering Technology – E-08-PN	WG appointed by the RPS
Revision 2 Draft B	23 June 2022	Reviewed submission from working Group	RDD&R BU and Education BU
Revision 2 Draft C	30 June 2022	Review and recommendation for Approval	Acting RPSC Executive
Revision 2	13 July 2022	Approval	
Revision 2	13 July 2022	error on the document making reference to "principle 7" replaced that with "relevant benchmark"	RPSC

CONTROLLED DISCLOSURE

When downloaded for the ECSA Document Management System, this document is uncontrolled and the responsibility rests with the user to ensure that it is in line with the authorised version on the database. If the 'original' stamp in red does not appear on each page, this document is uncontrolled.

Document No.: E-23-P	Revision No.: 2	Effective Date: 13/07/2022	
Subject: Engineering Qualifications in the Higher Education Qualifications Sub-framework			
Compiler: P Kutame	Approving Officer: MB Mtshali	Next Review Date: 13/07/2026	Page 17 of 17

Revision number	Revision date	Revision details	Approved by
Revision 2	15 Nov 2023	Minor changes to provide clarity Added the word Candidate in figure, 1 so that B1 shows that "Candidate Engineer" B2 and B4 "Candidate Engineering Technologist" B3 "Candidate Engineering Technician". Add E-09-PT Pathways P1.4	Acting RPSC Executive

The Engineering Qualifications in:

The Higher Education Qualifications Sub-Framework:

Revision 2 dated 13 July 2022 and consisting of 16 pages has been reviewed for adequacy by the Business Unit Assistant Manager and is approved by the Acting Executive: Research, Policy and Standards (**RPS**).



.....

Acting Manager

15 November 2023
.....

Date



Acting Executive: **RPS**

2023/11/15
.....

Date

This definitive version of this policy is available on our website.

CONTROLLED DISCLOSURE

When downloaded for the ECSA Document Management System, this document is uncontrolled and the responsibility rests with the user to ensure that it is in line with the authorised version on the database. If the 'original' stamp in red does not appear on each page, this document is uncontrolled.